

REIDMAR 750

PROFESSIONAL BASS HEAD



CONTENTS	Page
Introduction	2
Block Diagram	3
Front Panel Controls	4
Rear Panel Features	6
Specifications	8



About the EBS Reidmar 750 Bass Head!

The EBS Reidmar 750 provides a full bodied, warm and transparent tone throughout the entire range. It is equipped with EBS renowned built in compressor, professional balanced XLR-output, Character filter and an efficient 4-Band EQ and a Drive that lets you master the sound.

The EBS Reidmar 750 handles a 4 Ohm load. Due to its power rating (700W RMS), using mini-size cabinets calls for very careful use of the master Volume. It is strongly recommended to use Reidmar 750 with a 4 ohm cabinet that matches the power output of the amp.

The Reidmar amp is designed and developed in the heart of Sweden by EBS.

GETTING STARTED...

1. Carefully unpack the bass head.
2. Check that all knobs are set fully counter clockwise besides the EQ controls marked BASS, MIDDLE and TREBLE which should be set to mid position. Make also sure all push switches are set to their outer positions. Now the EBS Reidmar 750s settings are "zeroed" and ready to be personalized.
3. Connect one or more speaker cabinets to the speaker output. Make sure the total impedance is not below 4 ohms.
4. Turn on the POWER switch.
5. Plug in your bass. While plucking the strings as hard as you would during your hardest playing, gradually increase the GAIN knob until the peak LED starts to flash at peaks.
6. Move over to the VOLUME knob and adjust for the desired output volume.

BUILDING THE SOUND...

7. The first tonal shaping circuitry is the Character Filter next to the GAIN control. This filter provides a preshape EQ prior of further fine tuning of your sound.

8. Enable the filters by pressing the Filter Active pushbutton and explore the filter section. Play your bass. Note that there isn't any difference in sound yet.

9. The filters are basically of the boost/cut design. This means that the level controls marked with + and - signs, either boost or cuts the selected frequency band. Further, the MIDDLE section has got a frequency control for precise adjustment of the midrange.

10. Gradually increase or decrease the level and vary the frequency of the middle filter when operating the middle filter. Notice how the sound is effected. An A/B comparison can be made by toggling the filter active switch.

11. Proceed to the COMP/LIMIT knob. This control adjusts the compression and is useful when playing very dynamic or loud.

12. Turn up the COMP/LIMIT knob to mid and max position. Notice how the peaks in volume will straighten out as you play harder and harder.

13. Now, go on to the BRIGHT and turn it half way up. Play your bass. The BRIGHT filter is a high pass filter which works on the highest frequencies of the bass to give enhanced ambiance and presence.

14. Proceed to the DRIVE control and increase this setting gradually until desired level of over driven sound is reached.

This was a brief introduction and as you go on further in this manual, you will learn how to use and utilize all of the useful features that the EBS Reidmar offers you.

EBS REIDMAR 750 – BLOCK DIAGRAM

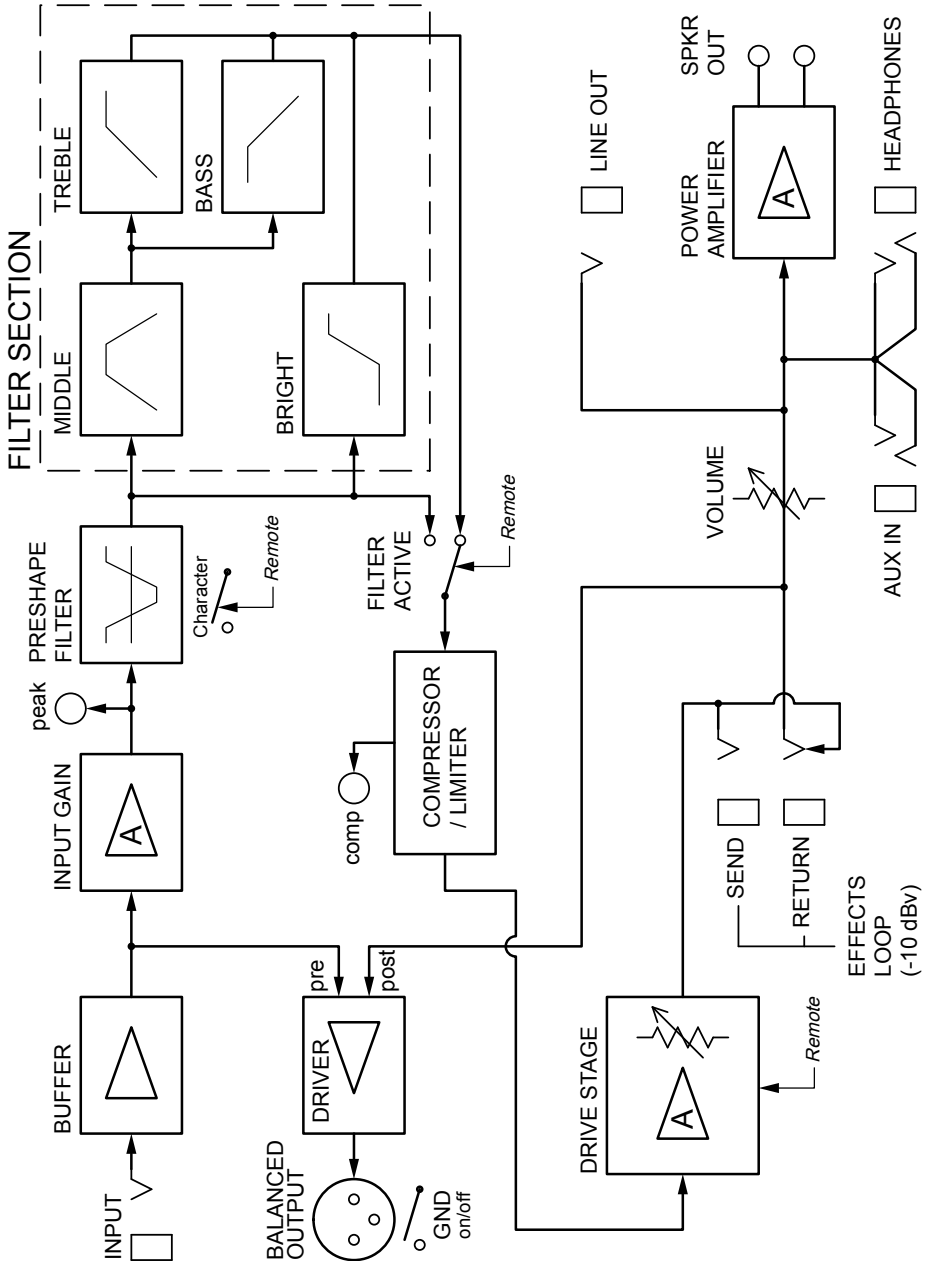

EBS REIDMAR 750 – FRONT PANEL CONTROLS



1. INPUT -A low noise, high impedance instrument input that will interface with passive and active instruments perfectly.

2. CHARACTER FILTER* -The EBS Reidmar 750 provides a preshape filter, Character, which operate independently from the other preamp functions. This gives the user the opportunity to preshape the sound before the final processing with the other features of the preamp. When on, boost is achieved in bass and treble ranges respectively, while the midrange has a slight drop in gain.

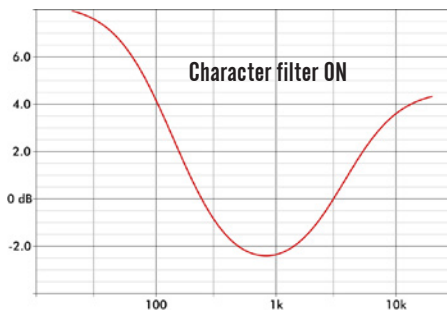

3. GAIN -Control to adjust the instruments' signal strength to the right operating level in the EBS Reidmar. For optimum basic signal level, turn up the GAIN knob until the PEAK led starts flashing from the strongest signal from the instrument.

Note: A correctly set GAIN is vital for the signal processing to work properly in the EBS Reidmar.

4. COMP/LIMIT -A low noise compressor limiter that works fast and effectively, tightening up the sound and preventing the bass head from saturating at peaks when approaching the headroom limit. A string may be plucked very hard and fast, without any greater difference in level or side effects. The COMP/LIMIT knob sets the compression ratio, i.e. The signal strength relation between the input and output; the higher ratio the more compression. The LED intensity dynamically indicates the amount of compression during play.

5. FILTERACTIVE* – This switch activates the filter section described under point 6.

6. FILTERS -The filter section contains four enhanced performance filters:

BASS is a 'shelving' type 12dB/oct slope phase compensated bass filter with a wide gain range.

MIDDLE has an extended frequency range of 100-6000 Hz. This filter facilitates total control over the mids, with a wide bandwidth giving a natural and non-peaking result using frequency dependent gain. In addition, at minimum setting this filter facilitates a notch function, suitable for cutting an exact frequency or eliminating acoustic coupling.

TREBLE is a shelving type filter controlling the higher mids and treble registers, giving presence and ambience to the sound.

BRIGHT is an advanced high pass filter capable of producing bright high treble timbre, without adding practically any noise.

7. DRIVE* - The DRIVE knob controls the amount of gain in the tube emulation stage, and provides an extra gain all the way up to 34 dB. The gain is compensated over this section producing a warm overdrive while the output remains more or less constant. This control also compresses the sound when turning up level up to maximum, producing pure limitation. This Drive function can be controlled by a footswitch remotely. See rear panel descriptions for more details.

8. VOLUME -The VOLUME knob controls all volume in the unit, controlling the poweramp and LINE output. The balanced output (XLR) is not affected by the setting of this knob.

9. PILOT LAMP -Indicates power on condition.

** Note: These features can be switched on and off with a footswitch (EBS RM-4, sold separately). The footswitch can be connected from the back of the amp and also features a Mute switch.*

Midrange filters

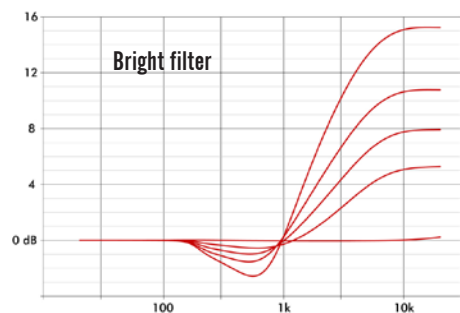
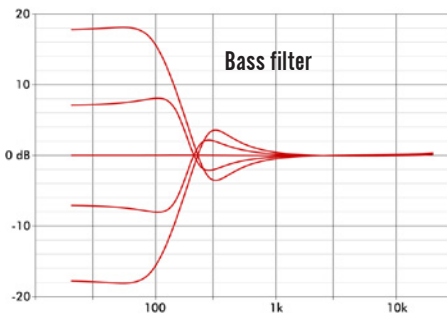
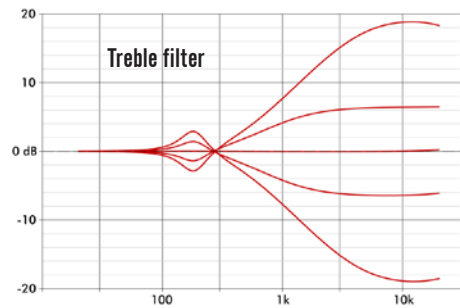
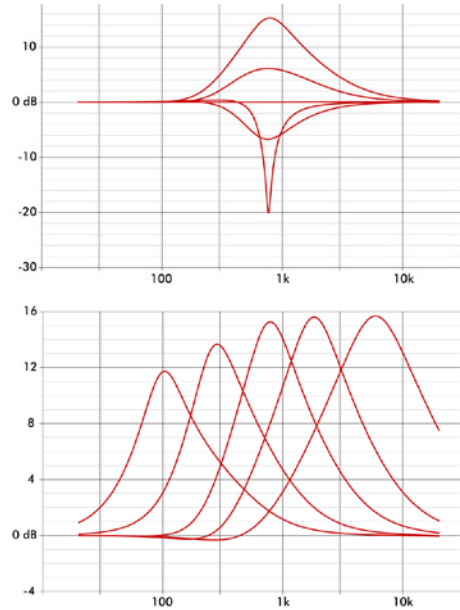

EBS REIDMAR 750 – REAR PANEL FEATURES

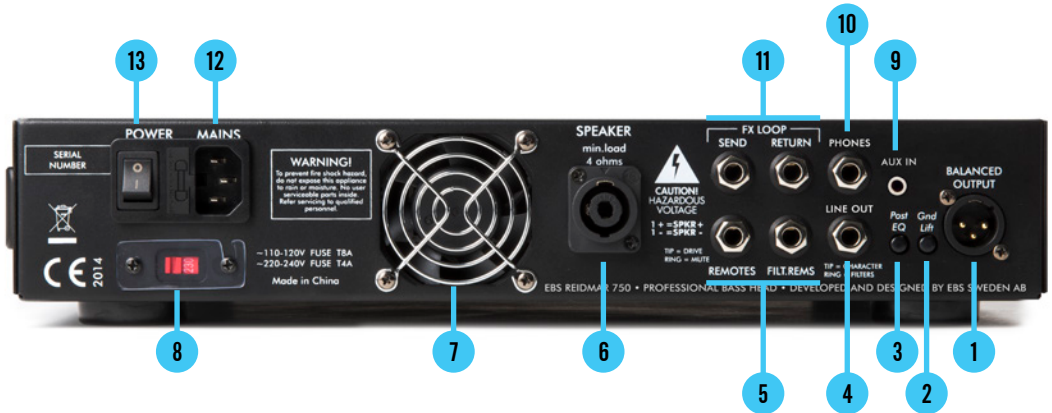

1. BALANCED OUTPUT -A balanced output functions as a high quality line box for connecting to PA mixing consoles or to studio or broadcast recording units, with high noise immunity. The volume level does not effect this output.

2. GND LIFT SWITCH -Lifting ground is a great aid in many occasions eliminating ground noise and hum. When required, set this switch to Lift position to disconnect the ground from the balanced output.

3. PRE/POST EQ SWITCH -The switch selects the signal source. In the inner position this switch selects the overall sound included settings on the EQ, otherwise, in the lower position an uncolored sound is taken immediately after the amplifiers input.

4. LINE OUT -This is a fullrange output that will drive multiple poweramps, extending the power of the system. The signal present at this output is taken after the volume control.

5. REMOTES – The EBS Reidmar 750 is equipped with two remote jacks for controlling with foot switches the character, filter active switches, drive section, plus a mute function. You may use any standard footswitch pedal making connection to ground for each of the remote functions. Refer to the rear panel screen print and technical specification for further info.

Note: Each of the filter switches on the front panel needs to be set to inner position in order to be remotely controlled.

6. SPEAKER OUTPUT – Connect your speakers here. Care should be taken when connecting speakers so that the minium total impedance is not lower than 4 ohms.

Warning: Lower impedance than 4 ohms may cause permanent damage to the amp. EBS will not take responsibility for eventual hearing damages caused by the powerful EBS Reidmar 750.

WARNING! DUE TO THE HIGH OUTPUT OF THE REIDMAR 750, BE CAREFUL NOT TO DAMAGE SPEAKER CABINETS BY EXCEEDING THEIR RATINGS!

7. SYSTEM FAN – The amps performance is maintained among other techniques with a fan controlling the temperature of the unit. Make sure not to cover the ventilation openings of the amp! IMPORTANT!

8. MAINS SELECTOR SWITCH -Selects the operating mains voltage. Unplug the amp before selecting the mains voltage!

9. AUX IN - This input will accept a stereo or mono 3.5mm plug and gives you the option of mixing in an external source such as MP3 player or similar to the Reidmar 750. Since this input does not have any level control, be sure to control the volume from the source. Both channels will be mixed in from this input. The signal at this input will not be present at the balanced output.

10. PHONES - 1/4" stereo contact to connect a pair of standard headphones.

11. EFFECTS LOOP – This is a serial effects loop for the use of external units such as box or rack effects. Nominal level is set for use with standard stomp boxes. The loop puts the external effects after the filter, compressor and drive sections.

12. MAINS – Connect only to the indicated mains AC voltage and replace fuse if needed only with same type and value.

13. POWER -Switches the amp on or off.

INPUT:	Input Impedance		1 Mohms // 100 pF
GAIN:	Gain Range	min/max	-∞/ +30 dB
	Gain Peak LED		+10 dBv
	Frequency Response	+0 / -3 dB	20 -20.000 Hz
CHARACTER:	Filter:	Type	Shelving High/Low Pass
	Gain:	Low	+7 dB @ 40 Hz
		Mid	-2dB@ 800Hz
		High	+3 dB @ 10 kHz
COMP/LIMIT:	Compressor Gain		0 dB
	Attenuation	max	24 dB
	Compression Ratio	max	3:1
	Attack (80%)	typ.	<10 ms
	Release (80%)	typ.	100 ms
FILTER SECTION:	Bass Filter:	Type	12 dB/oct. Shelving
		Gain Range	+/-18dB @ 60Hz
	Middle Filter:	Type	Bandpass Filter
		Frequency Range	100 -6.000 Hz
		Q -Boost	0.7 -1.1
		Q -Cut	0.8 ->10
	Treble Filter:	Gain Range	+/-12-15 dB
		Type	Shelving
		Gain Range	+/-18dB@6kHz
	Bright:	Type	Shelving
Gain Range		+15/-0 dB @ 10 kHz	
DRIVE SECTION:	Gain Range	min/max	0 / 34 dB
	Low End Compensation	(Boost off)	< 350 Hz
BALANCED OUTPUT:	Output Level	Nominal	-10dBv
	Frequency Response	+0/-3 dB	10-20.000 Hz
	XLR Connections		1-GND, 2-Hot, 3-Cold
EFFECT LOOP:	Options		GND Lift, Pre/Post EQ
	Loop Signal Level	nominal	-10 dBv
	Gain		Unity (1:1)
	Output Impedance		100 ohms
LINE OUT:	Input Impedance		>50 kohms // 100 pF
	Output Impedance		100 ohms
PHONES OUT:	Signal Level	nominal	0 dBv
	Impedance	recommended	32 -200 ohms
AUX INPUT:	Input Impedance		5 kohms
	Nominal Level		-10 dBv
REMOTES:	Connection:	REMOTE JACK:	RING = Mute TIP = Drive
		FILTER JACK:	RING = Filter Section TIP = Character
	Function:		Connect to GND for bypass.
	Threshold:		0.7 V
	Current :		5 mA suitable for LED
	POWER AMP:	Output Power	@4 ohms
Minimum Recommended Load Impedance			4 ohms
Protection			Over current, thermal and high frequency (HF).
AUXILIARY INFO:	Power Requirements		max 850 W
	Mains Protection:		T5A Fuse (230V) T10A Fuse (100/120V)
	Dimensions (WxDxH)	max	38.5 x 26.5 x 7.5 cm (15.2 x 10.4 x 3.0")
	Weight	net	3.7 kg (8.2 lbs)

Specifications are subject to change without notice!

EBS REIDMAR 750 - PROFESSIONAL BASS HEAD

DESIGNED AND DEVELOPED BY EBS SWEDEN AB • GRINDSTUVÄGEN 44-46, SE-16733 BROMMA, SWEDEN
PHONE +46 87350010, FAX: +4687350005 • E-MAIL: info@ebssweden.com WEB: www.ebssweden.com